









Product datasheet

Product name Internal extractor
Product number 21-0
Product series
EAN 4021176010408



Technical attributes

Attribute name	Attribute value
 ball bearing ISO	625; 635; 626; 607; 627; 608; 619/8; 628/8
 inner diameter of ball bearing	5 - 8 mm (1/4 - 3/8 inch)
 effective depth	14 mm (5/8 inch)
 length of internal extractor	73 mm (2 7/8 inch)
 number of segments	2
 weight	0.1 kg

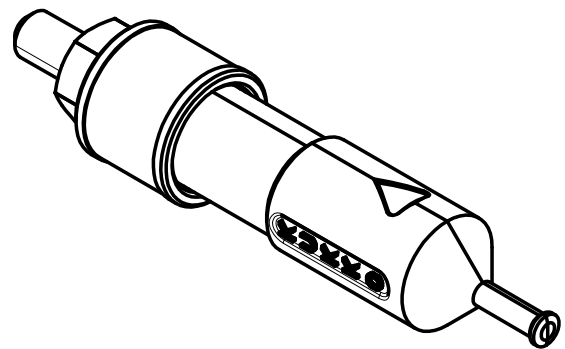
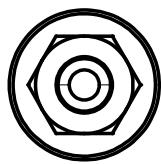
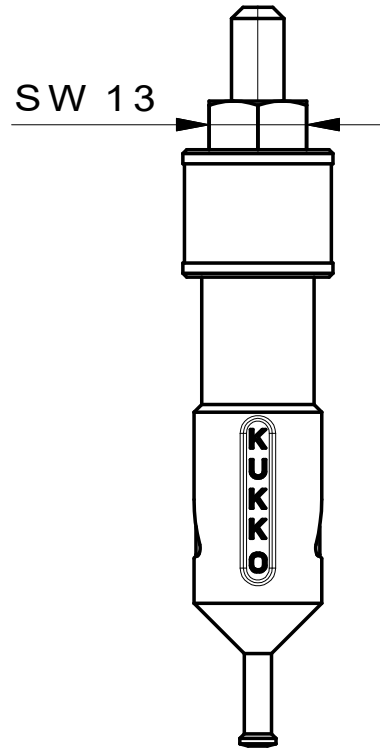
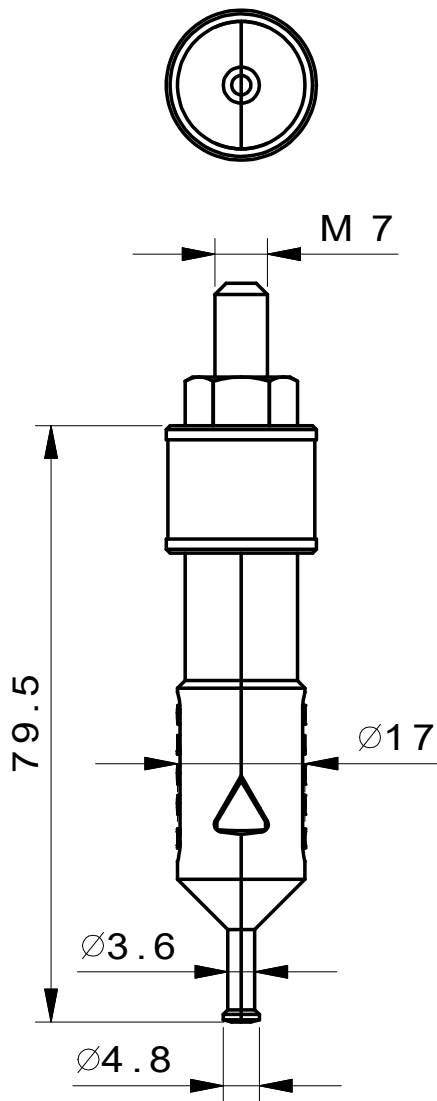

**Kleinbongartz
& Kaiser
oHG**
Werkzeugfabrik
Hilden - Germany

Dokumentname:
21-0 Innenauszieher

Toleranz:
DIN ISO 2768-m

Dokumentbeschreibung:
ZSB

Material:
Hochfester extra zäher Vergütungsstahl/
High tensile strength and toughness steel

Erstellt / Geprüft von:
Schultes

Erstellungsdatum:
05/06/2015

Maßstab:
1:1

Teilbeschreibung:
Innenauszieher/ Internal extractor

Wärmebehandlung / Härte:
vergüteter Stahl/ tempered steel

Oberflächenbehandlung:

Artikelnummer / ZNR.:
21-0

Dokumentversion:
-

Schutzvermerk
ISO 16016
beachten