









Product datasheet

Product name Internal extractor
Product number 21-5
Product series
EAN 4021176011498



Technical attributes

Attribute name	Attribute value
 ball bearing ISO	6006; 6206; 6306; 6406; 16006; 61806; 61906; 6007; 6207; 6307; 6407; 16007; 61807; 61907; 6008; 6208; 6308; 6408; 16008; 61808; 61908
 inner diameter of ball bearing	28 - 40 mm (1 3/16 - 1 5/8 inch)
 effective depth	30 mm (1 3/8 inch)
 length of internal extractor	101 mm (4 inch)
 number of segments	2
 weight	0.4 kg

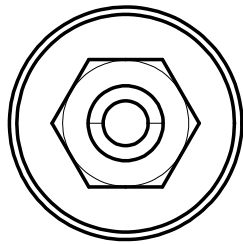
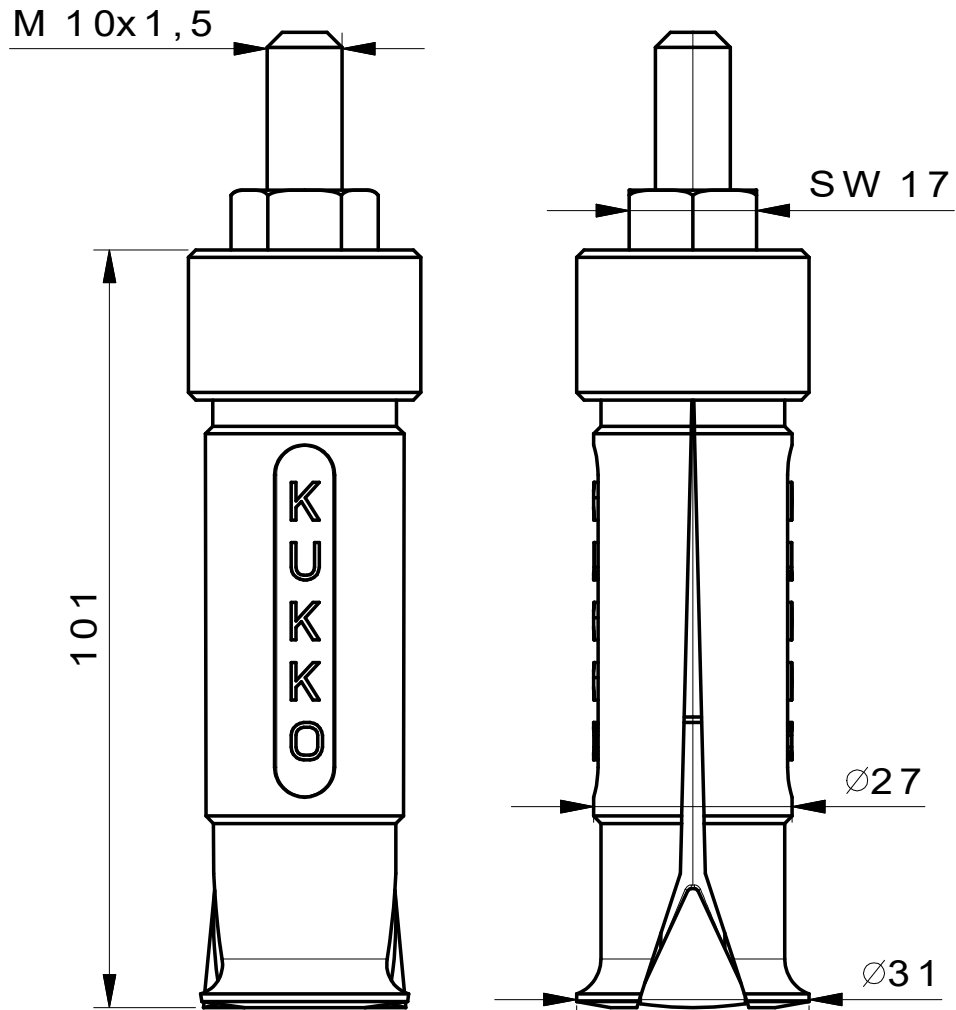

 Kleinbongartz & Kaiser oHG Werkzeugfabrik Hilden - Germany	Dokumentname: 21-5 Innenauszieher		Toleranz: DIN ISO 2768-m	
	Dokumentbeschreibung: Baugruppe		Material: Hochfester extra zäher Vergütungsstahl/ High tensile strength and toughness steel	
	Erstellt / Geprüft von: Schultes	Erstellungsdatum: 30/03/2015	Maßstab: 1:1	
Teilbeschreibung: Innenauszieher/ Internal extractor			Wärmebehandlung / Härte: vergüteter Stahl/ tempered steel	
			Oberflächenbehandlung:	
Artikelnummer / ZNR.: 21-5	Dokumentversion: -	Schutzvermerk ISO 16016 beachten		