



Product datasheet

Product name Internal extractor







Product number 21-01

Product series

EAN 4021176010651



Technical attributes

Attribute name	Attribute value
 ball bearing ISO	608; 619/8; 628/8; 609; 618/9; 629; 6000; 6200; 6300; 6800; 6900; 61800; 61900; 62200; 62300; 6001; 6201; 6301; 6801; 6901; 16001; 16101; 61801; 61901; 62201; 62301
 inner diameter of ball bearing	8 - 12 mm (3/8 - 3/16 inch)
 effective depth	14 mm (5/8 inch)
 length of internal extractor	73 mm (2 7/8 inch)
 number of segments	2
 weight	0.1 kg

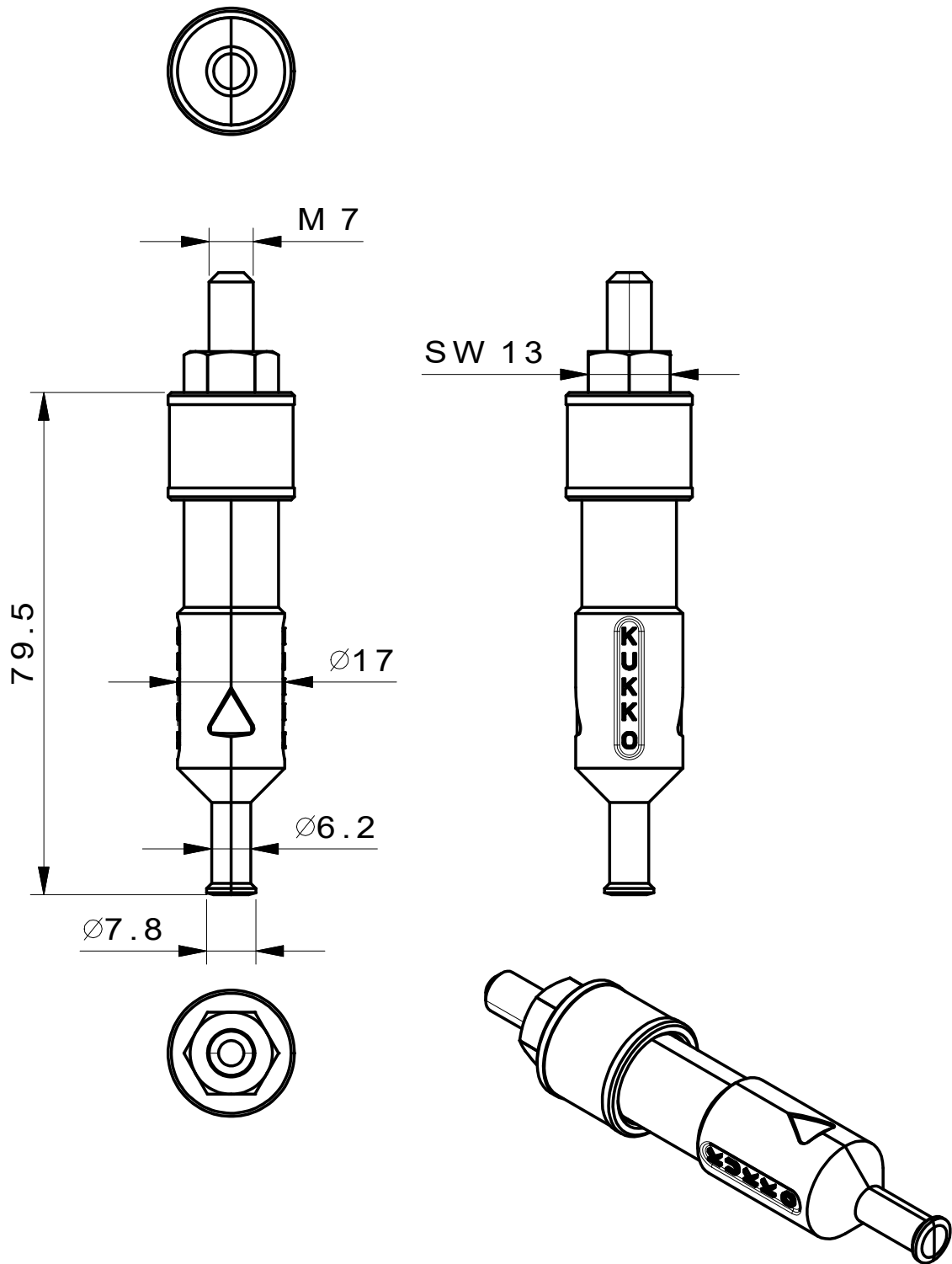

 <p>Kleinbongartz & Kaiser oHG Werkzeugfabrik Hilden - Germany</p>	Dokumentname: 21-01 Innenauszieher		Toleranz: DIN ISO 2768-m	
	Dokumentbeschreibung: ZSB		Material: Hochfester extra zäher Vergütungsstahl/ High tensile strength and toughness steel	
	Erstellt / Geprüft von: Schultes	Erstellungsdatum: 05/06/2015	Maßstab: 1:1	
Teilbeschreibung: Innenauszieher/ Internal extractor			Wärmebehandlung / Härte: vergüteter Stahl/ tempered steel	
			Oberflächenbehandlung:	
Artikelnummer / ZNR.: 21-01	Dokumentversion: -		Schutzvermerk ISO 16016 beachten	