











Product datasheet

Product name	2-jaw puller For removing bearings, gears, discs, etc.
Product number	20-3
Product series	20
EAN	4021176009686



Technical attributes

Attribute name	Attribute value
 spread	250 mm (9 7/8 inch)
 depth	200 mm (7 7/8 inch)
 spread used internal	180 - 340 mm (7 1/8 - 13 3/8 inch)
 hexagon drive (male)	27 mm
max. maximum load	8.5 t (9.5 US t)
 max. maximum torque	300 Nm
 max. maximum torque	221 ft lb
 weight	7.1 kg
 ^x Number of jaws	2

Spare part

Product number	Product name
626300	Mechanical pressure spindle.
3-200-P	2 pulling jaws (pair)
20-3-T	2-jaw cross bar

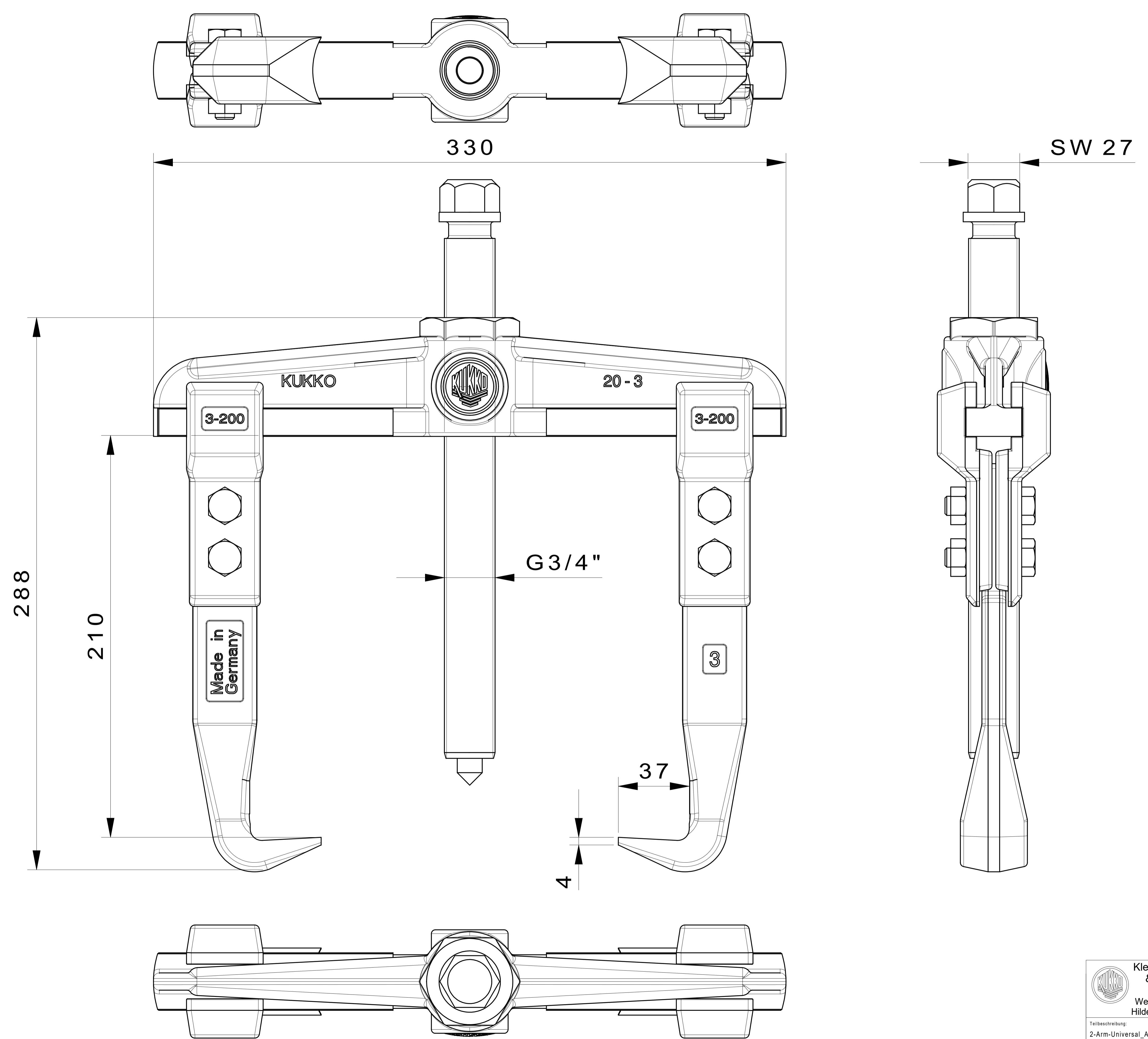

 Kleinbongartz & Kaiser oHG Werkzeugfabrik Hilden - Germany	Dokumentname: 20-3_2-Arm-Universal_Abzieher	Toleranz: DIN ISO 2768-m
	Dokumentbeschreibung: Baugruppe	Material: Hoch legierter Werkzeugstahl / High alloy tool steel
Erstellt / Geprüft von: Schultes	Erstellungsdatum: 30/03/2015	Maßstab: 1:1
Teilbeschreibung: 2-Arm-Universal_Abzieher/ 2-jaw puller		Wärmebehandlung / Härte: vergüteter Stahl/ tempered steel
Artikelnummer / ZNR: 20-3	Dokumentversion: -	Schutzvermerk: ISO 16015 beachten