









# Product datasheet

<b>Product name</b>	Internal extractor For extracting inner bearings, bearing outer rings and bushings.
<b>Product number</b>	21-02
<b>Product series</b>	21
<b>EAN</b>	4021176010736



## Technical attributes

Attribute name	Attribute value
 ball bearing ISO	6000; 6200; 6300; 6800; 6900; 61800; 61900; 62200; 62300; 6001; 6201; 6301; 6801; 6901; 16001; 16101; 61801; 61901; 62201; 62301
 inner diameter of ball bearing	10 - 14 mm (3/8 - 5/8 inch)
 effective depth	14 mm (5/8 inch)
 length of internal extractor	73 mm (2 7/8 inch)
 number of segments	2
 weight	0.1 kg

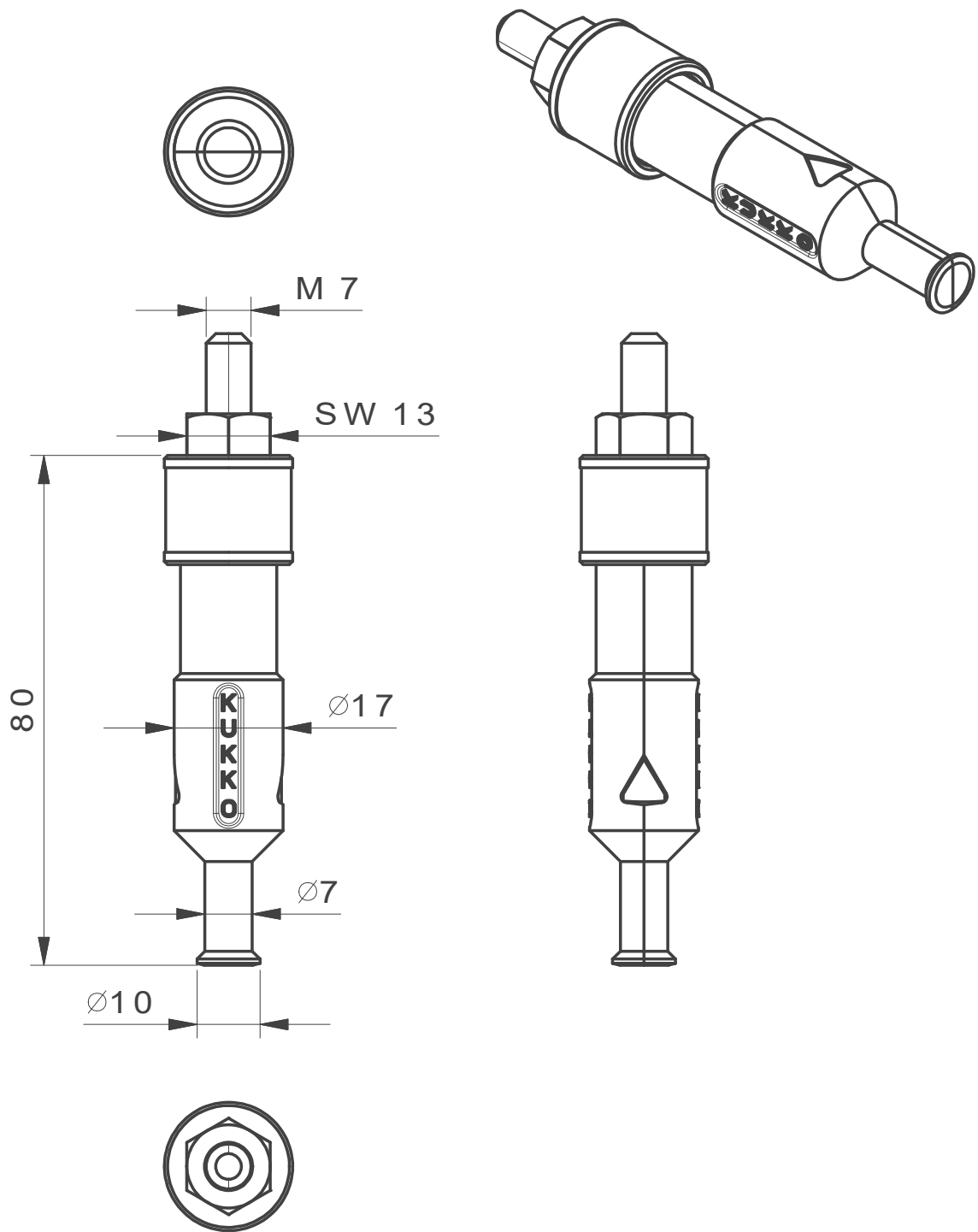

**Kleinbongartz  
& Kaiser  
oHG**  
Werkzeugfabrik  
Hilden - Germany

Dokumentname:  
21-02 Innenauszieher

Toleranz:  
DIN ISO 2768-m

Dokumentbeschreibung:  
ZSB

Material:  
Hochfester extra zäher Vergütungsstahl/  
High tensile strength and toughness steel

Erstellt / Geprüft von:  
Schultes

Erstellungsdatum:  
05/06/2015

Maßstab:  
1:1

Teilbeschreibung:  
Innenauszieher /Internal extractor

Wärmebehandlung / Härte:  
vergüteter Stahl/ tempered steel

Oberflächenbehandlung:

Artikelnummer / ZNR.:  
21-02

Dokumentversion:  
-

Schutzvermerk  
ISO 16016  
beachten